



ELECTRICAL SYSTEMS

Sceptalight[™]

- LED Light Fixture
- Incandescent Light Fixture
- Compact Fluorescent Light Fixture

www.kraloyfittings.com

SCEPTALIGHT™: THE LIGHT THAT LASTS.

Whether you're looking for economical outdoor lighting solutions, corrosion-resistant fixtures for punishing industrial environments or energy-saving LED, Sceptalight fixtures from Kraloy prove themselves to be all-round performers in a variety of indoor and outdoor applications. Sceptalight fixtures are made from a glass-reinforced thermoplastic polyester resin, which enables them to stand up better to corrosive elements than metal. This thermoplastic design marries an unrivaled balance of strength, stiffness and toughness with all the benefits users appreciate of Scepter Rigid PVC Conduit and Kraloy Fittings – long life, easy servicing and high impact-resistance.

Sceptalight's thermoplastic construction offers outstanding corrosion and chemical resistance. Silicone gaskets in Sceptalight fixtures – mounted at the base of the globe and within the ceiling box – provide a water- and vapour-tight seal which protects the electrical connections inside.

Wherever you need a lighting fixture that can withstand exposure to chemicals, fluids or harsh physical conditions, you'll find a home for Sceptalight.

TYPICAL APPLICATIONS



⚠ Agriculture



⚠ Industrial/Commercial



☠ Mine Tunnel



☠ Greenhouse



☠ Waste Water



☠ Marine



WET LOCATIONS

C22.2 No. 250

CSA Listed to UL 1598

Minimum 60°C supply conductors

CSA certified for wet locations, Sceptalight fixtures are built to withstand any environment where liquids drip, splash or flow against electrical equipment. And our polycarbonate globes are an excellent alternative to glass in punishing environments where high impact resistance is important. Sceptalight fixtures can operate in extreme temperatures and are resistant to damaging ultraviolet rays. For years, our fixtures have been proven performers on docks, wharfs, decks, walkways, shipyards and a variety of other applications where exposed to the elements.

LIGHT OPTIONS	
LED	✓
Incandescent	✓
Compact Fluorescent	✓



HAZARDOUS LOCATIONS

CSA Listed to UL 844

CLASS I, DIV 2 Groups A, B, C & D

CLASS II, DIV 2 Groups F & G

Minimum 90°C supply conductors

Sceptalight offers fixtures that are CSA certified for hazardous locations, making them the ideal choice for specific harsh industrial environments involving flammable or explosive gases, vapors or dust. Sceptalight fixtures are equipped with brass screws and inserts to ensure performance in punishing industrial conditions.

LIGHT OPTIONS	
LED	✓

SUGGESTED SPECIFICATION

Light fixtures shall be nonmetallic and constructed of 30% glass filled polyester material exhibiting a maximum linear expansion of 1.4x10⁻⁵ in./in./°F. Fixtures shall be assembled with high temperature silicone gaskets, brass inserts and screws.

Incandescent light fixtures shall be rated for use with a Maximum 150 Watt incandescent lamp. Compact fluorescent light fixtures shall be of the wattage specified and be supplied complete with lamp and ballast (high power factor, low harmonic electronic for 18 & 26 Watt fixtures.

LED light fixtures shall be third-party certified to CSA 22.2 250.0 and UL 1598C. LED light fixtures will also be NEMA 4X and IP66 rated for wash-down and corrosive environments. LED light fixtures for hazardous use locations shall be third-party certified to UL 844 for Class I Div 2 and Class II Div 2 hazardous location use.

LED Retrofit Light Engines shall be certified to CSA 22.2 no 250.1 and UL 1598C.

Approved products: Sceptalight LVPE and LVPL series light fixtures manufactured by Kraloy.





SCEPTALIGHT™ LED

Sceptalight LEDs provide exceptional light quality compared to conventional light sources. Due to their wider spectral distribution, objects lit by Sceptalight LEDs are much more visible and vivid in color.

Introducing three new Sceptalight LED products: the LED Retrofit Light Engine, the Heavy-Duty LED Light Fixture and the Utility LED Light Fixture. Sceptalight LEDs offer significant energy savings, up to 85% compared to incandescent, and up to 34% compared to fluorescents. Moreover, Sceptalight LEDs can last beyond 50,000 hours without a single need for maintenance.

Constructed of very strong and durable materials, the polycarbonate globe is impact resistant and is resistant to UV light degradation. The specially designed aluminum heat sink dissipates the heat generated by the LEDs to the exterior environment ensuring long-life and optimal performance in both hot and cold environments. Sceptalight LEDs have been tested and certified for use in indoor, outdoor, wet location, wash down, corrosive and hazardous* environments. They are certified to the latest LED light fixture standards and NEMA 4X approved.

* LVPF-LED-HAZ only



RETROFIT OPTION

Sceptalight LEDs can easily retrofit onto existing installations for increased energy savings.

CORROSION RESISTANT

Heat sink is coated with a durable e-coat layer that prevents corrosion.

NEMA 4X AND IP66 RATED

Approved for wet locations, wash down and corrosive environments.

HEAT DISSIPATION

Specially designed heat sink ensures long life and optimum performance for over 50,000 hours.

ENERGY EFFICIENT

1,575 lumens of light output is produced with only 15 Watts of electricity.

DIMMABLE

Lights are dimmable down to 5% for maximum control of the lighting environment.

POLYCARBONATE GLOBE

Impact and weather resistant for tough environments.

TECHNICAL SPECIFICATIONS

LUMEN OUTPUT.....	1575 LM	POWER FACTOR	0.98
INPUT VOLTAGE	120 VAC	TOTAL HARMONIC DISTORTION	10.5%
FREQUENCY	60 HZ	OPERATING TEMPERATURE.....	-40 °C TO 40 °C
NOMINAL POWER.....	15 W	DIMMABILITY RANGE.....	DOWN TO 5%
COLOR TEMPERATURE.....	5000 K	RATED LIFE	> 50,000 HOURS
CRI	> 80	WARRANTY'	5 YEARS

STANDARDS

PRODUCT	APPROVED USE	STANDARDS
LLED-15 (light engine only)	WET LOCATION	CSA C22.2 250, UL 1598C
LVPE-LED	WET LOCATION	CSA C22.2 250, UL 1598C
LVPF-LED-HAZ	HAZARDOUS LOCATION	CSA C22.2 250, UL 1598C, UL 844
	Class I, Div 2 Groups A, B, C & D and Class II, Div 2 Groups F & G	

PHOTOMETRIC DATA

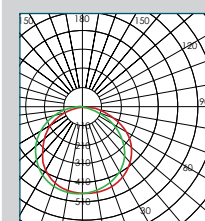

15W 120V
Frosted LED

*LIMITED WARRANTY & LIMITATION OF LIABILITY: Consult Kraloy Sceptalight™ LED Retrofit Light Engine Specific Terms and Conditions of Sale and Limited Warranty and Limitation of Liability for further details, available at kraloyfittings.com



SCEPTALIGHT™

COMPACT FLUORESCENT

Sceptalight Compact Fluorescent fixtures provide lower energy and maintenance costs without sacrificing light levels. The UV resistant material makes them suitable for both indoor and outdoor use.

Sceptalight Compact Fluorescent fixtures combine the outstanding corrosion and chemical resistance of their thermoplastic design with the energy-saving advantages of compact fluorescents. Working four to five times more efficiently per watt than incandescents, Sceptalight compact fluorescents provide 10-20 times the lamp life. Without sacrificing light levels, they use 75% less energy than incandescents for a lower total energy and maintenance cost. They are available in twin tube and quad tube configurations and include ballast.

Quad Tubes

- Available in 18 & 26 Watt
- Electronic Ballast provides "Instant Start" at temps as low as -25°C
- Offers 10,000 hours of lamp life



STABLE CONSTRUCTION

Reinforced support feet offer secure mounting.

ADAPTABLE

Threaded conduit hubs permit connection to nonmetallic and metallic raceways.

WATERTIGHT SEAL

Temperature and weather-resistant gaskets protect fixture from moisture penetration.

LONG LIFE

Sceptalight nonmetallic fixtures provide long life and easy servicing—unlike metal fixtures and guards that can corrode and seize together.

INDOOR/OUTDOOR USE

UV-resistant material makes Sceptalight fixtures suitable for both indoor and outdoor use.

CORROSION RESISTANT

Thermoplastic construction resists attack from acids, alcohols, alkalis, organic solvents, detergents/cleaners, greases and oils as well as many other types of chemicals. Withstands exposure to direct sunlight, heat, and extreme weather.

DURABLE, IMPACT RESISTANCE

High-impact nonmetallic guard resists physical impact, chemical attack and heat-induced deformation.

PHOTOMETRIC DATA

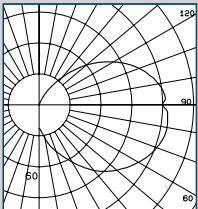

26W Quad
Compact
Fluorescent

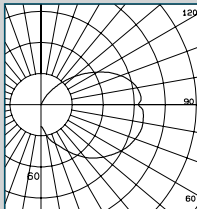

18W Quad
Compact
Fluorescent



SCEPTALIGHT™

INCANDESCENT

Sceptalight Incandescent fixtures are your cost effective solution for a variety of indoor and outdoor applications while still providing superior corrosion and chemical resistance.

Sceptalight incandescent fixtures make the most practical choice to meet the daily needs of commercial, industrial, marine and agricultural applications. Our incandescents will take up to a 150 watt incandescent bulb and are ideal for short burn times as well as flashing and dimming applications.

For light to medium duty applications that do not require the same level of ruggedness, Sceptalight has a low-cost ceiling-mounted Utility Light Fixture available in standard, clear polycarbonate and colored heat-resistant globes.



INSTALLATION FLEXIBILITY

Fixtures can be mounted in ceilings, or walls to accommodate installation requirements.

INDOOR/OUTDOOR USE

Temperature and weather-resistant gaskets protect fixture from moisture penetration.

COST EFFECTIVE SOLUTION

Inexpensive to install, the fixture takes up to a 150 watt incandescent bulb.

ADAPTABLE LIGHTING ENVIRONMENTS

Ideal for short burn times, flashing & dimming applications.

COLORED GLOBES

Available in a range of colored heat-resistant globes to transform the light into an indicator or warning light.

CORROSION RESISTANT

Thermoplastic construction withstands exposure to direct sunlight, heat & extreme weather.

PHOTOMETRIC DATA

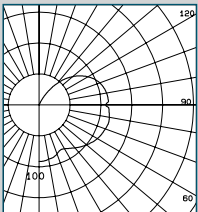

100W 120V
Coated A19
Incandescent

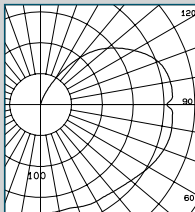

150W 120V
Coated A21
Incandescent

PRODUCT CATALOGUE

WET LOCATIONS



Ceiling Mount with Frosted Polycarbonate Globe

Description	Part Number	Product Code	Hub Sizes
15W LED Retrofit Light Engine	LLED-15	277120	-
15W LED LVPF Heavy Duty Light Fixture	LVPF-LED-HAZ	277121	4 x 3/4"
15W LED LVPE Utility Light Fixture	LVPE-LED	277122	2 x 1/2" - 2 x 3/4"

Ceiling Mount with Standard Clear Glass Globe

Description	Part Number	Product Code	Hub Sizes
26W Compact Fluorescent	LVPL26C	077170	4 x 3/4"
18W Compact Fluorescent	LVPL18C	077210	4 x 3/4"

Ceiling Mount with Clear Polycarbonate Globe (no guard)

Description	Part Number	Product Code	Hub Sizes
26W Compact Fluorescent	LVPL26PCC	077176	4 x 3/4"
18W Compact Fluorescent	LVPL18PCC	077211	4 x 3/4"

Wall Mount Bracket

Description	Part Number	Product Code	Hub Sizes
Wall Mount bracket	LWB150	077233	-

For wall mount fixtures select and order the appropriate style (wattage and globe) ceiling mount fixture from above and add LWB150. Sceptalight compact fluorescent light fixtures are supplied complete with lamp and ballast.

Ceiling Utility Light Fixture 150 Watt Incandescent

Description	Part Number	Product Code	Hub Sizes
w/ Standard glass globe	LVPE150-10/15	077493	2 x 1/2" - 2 x 3/4"
w/ Polycarbonate globe	LVPE150-PCC	077181	2 x 1/2" - 2 x 3/4"
w/ Standard glass globe & guard Maximum 60W incandescent lamp with polycarbonate globe	LVPE150-10/15G	077402	2 x 1/2" - 2 x 3/4"
w/ Heat-resistant glass globe RED	LVPE150HRR	077599	2 x 1/2" - 2 x 3/4"
w/ Heat-resistant glass globe BLUE	LVPE150HRB	077579	2 x 1/2" - 2 x 3/4"
Clamp-on guard for LVPE	LVUG150	077558	-

HAZARDOUS LOCATIONS



Ceiling Mount with Frosted Polycarbonate Globe

Description	Part Number	Product Code	Hub Sizes
15W LED LVPF Heavy Duty Light Fixture	LVPF-LED-HAZ	277121	4 x 3/4"

All hazardous location fixtures are rated CLASS I, DIV 2 Groups A, B, C & D and CLASS II DIV 2 Groups F & G.

MOUNTING OPTIONS

Sceptralight LED can be retrofit with Ceiling Mounts only.

CEILING MOUNT

Box with threaded hubs and integral mounting feet

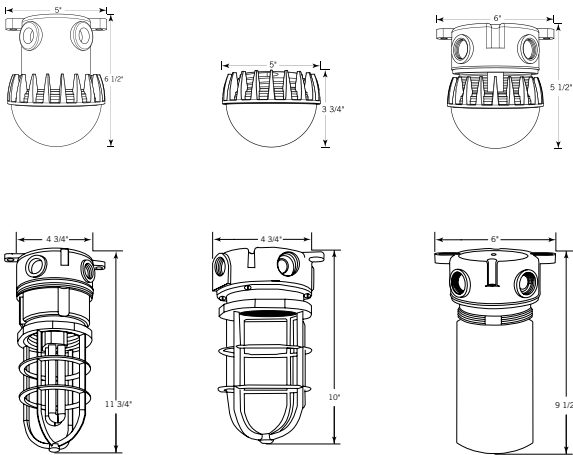

CEILING MOUNT UTILITY FIXTURES

Box with threaded hubs and integral mounting feet

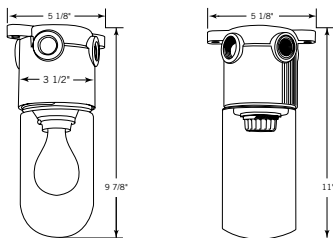

GLOBE OPTIONS

(For incandescent and fluorescent options only)

STANDARD CLEAR GLASS GLOBES

Ideal for general purpose area lighting for either indoor or outdoor use.

CLEAR POLYCARBONATE GLOBES

Impact resistant globes for added protection in case of accidental contact

COLORED HEAT-RESISTANT GLASS GLOBES

Available in red or blue – to transform the light to an indicator or warning light.



Clear Polycarbonate



Standard or Heat-Treated Clear Glass



Heat-Treated Blue Glass



Heat-Treated Red Glass

CUSTOMER SERVICE CENTER

1055 Wilton Grove Road
London, Ontario N6A 4K3

Tel: (519) 681-2140
Toll Free: (800) 265-1815
Fax: (519) 681-2156

www.kraloyfittings.com

Kraloy has been an industry leader for over 40 years supplying the electrical trade with a comprehensive offering of nonmetallic PVC fittings. Kraloy offers adapters, couplings, elbows, access fittings, boxes, cover plates, expansion fittings and spacers – virtually any fitting required to complete the PVC conduit system.

Check out the full Kraloy product offering on our web site www.kraloyfittings.com or contact us directly for information.

Only when you specify Kraloy by name are you guaranteed The Fitting Choice.

Kraloy is proud to offer these quality brands.

 **KRALOY**[®]

 **KWIKON**[®]
ENT & FITTINGS

 **Sceptalight**[™]
Nonmetallic Light Fixtures

 **KWIKFLEX**[®]
LIQUIDTIGHT FLEXIBLE NONMETALLIC CONDUIT & FITTINGS

 **Sceptacon**[™]
Trenchless Raceways Systems

 **INEXO**[™]
THE ICF BOX

Products are manufactured by IPEX Electrical Inc. and distributed in the United States by Kraloy, a division of Multi Fittings Corp.

Kraloy[®] is a trademark of Multi Fittings Corp.

INEXO[™], Kwikon[®], Kwiflex[®] and Sceptalight[™] are trademarks of IPEX Branding Inc.

DISTRIBUTED BY:

www.kraloyfittings.com

This literature is published in good faith and is believed to be reliable. However, Kraloy does not represent and/or warrant in any manner the information and suggestions contained in this brochure. Data presented is the result of laboratory tests and field experience. Kraloy maintains a policy of ongoing product improvement. This may result in modifications of features and/or specifications without notice.

 **KRALOY**[®]